

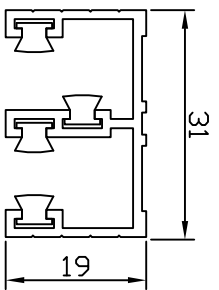

Ingersoll Rand
Security Technologies

HENDERSON



512 Top Guide Channel
Aluminum

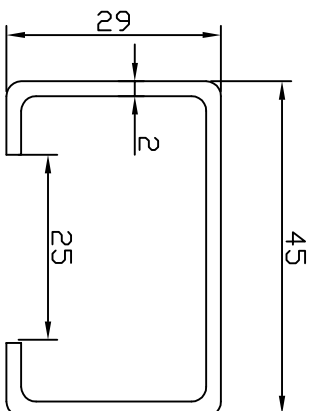

900 Top Guide Channel
Steel

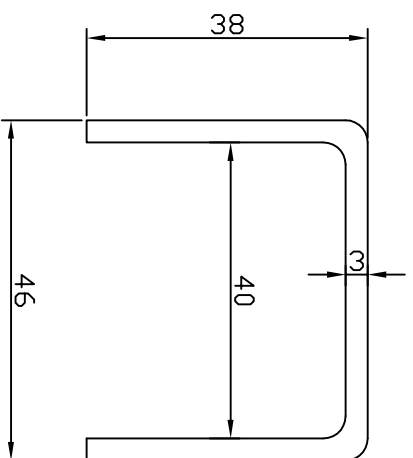

99 Top Guide Channel
Steel

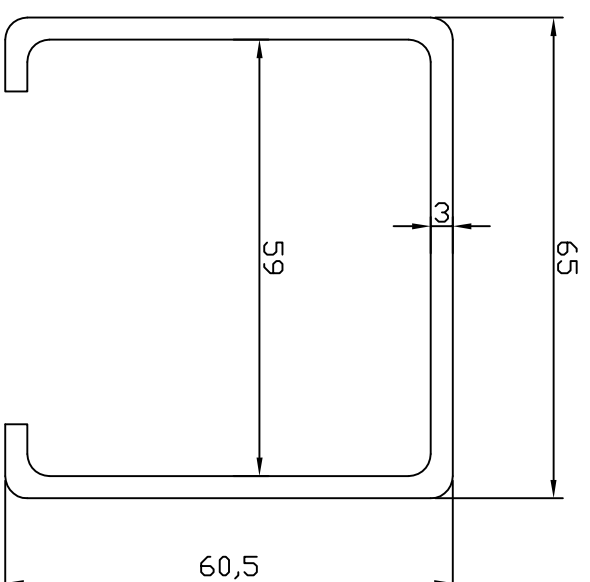

13 Top Guide Channel
Steel

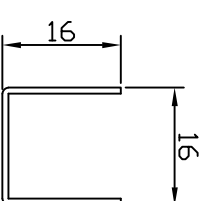

93 Guide Channel
Steel

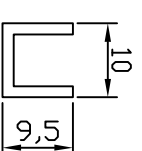

81X Guide Channel
Aluminum

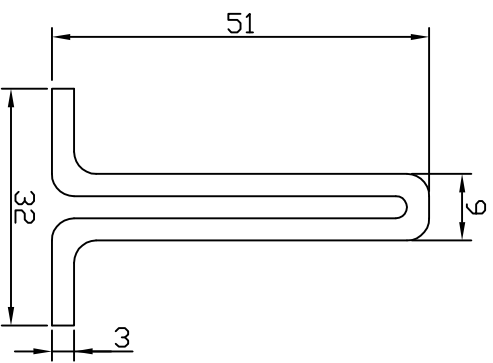

299 Bottom Rail
Steel

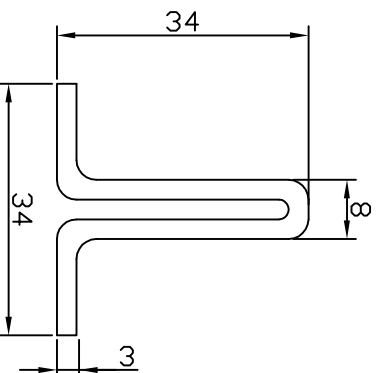

298 Bottom Rail
Steel

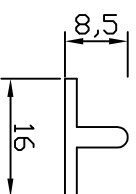

80X Bottom Rail
Aluminum

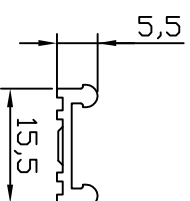

510 Bottom Rail
Aluminum

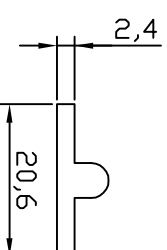

915X Bottom Rail
Aluminum

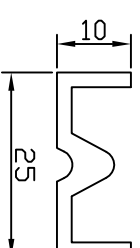

918 Bottom Rail
Brass

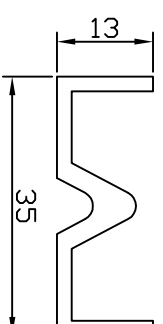

917 Bottom Rail
Brass

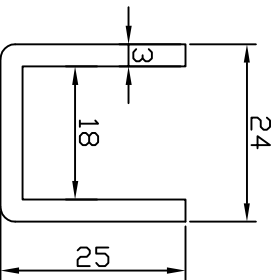

89 Guide Channel
Steel

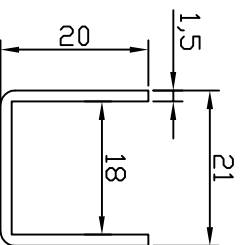

94 Guide Channel (Steel)
94X Guide Channel (Alu)

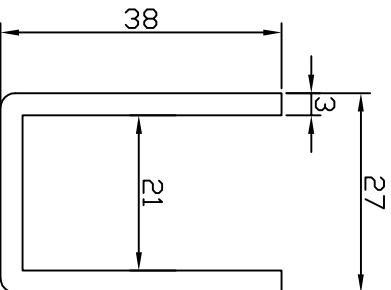

97 Guide Channel
Steel

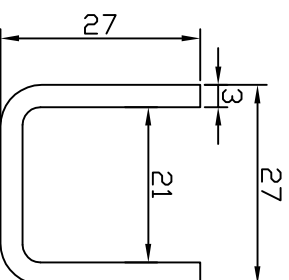

100 Guide Channel
Steel

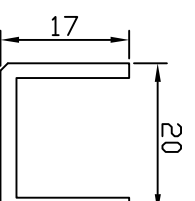

94P Guide Channel
Polypropylene

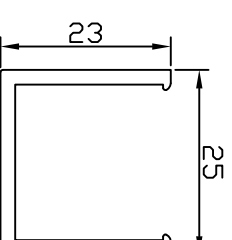

94SC Support Channel
Aluminum

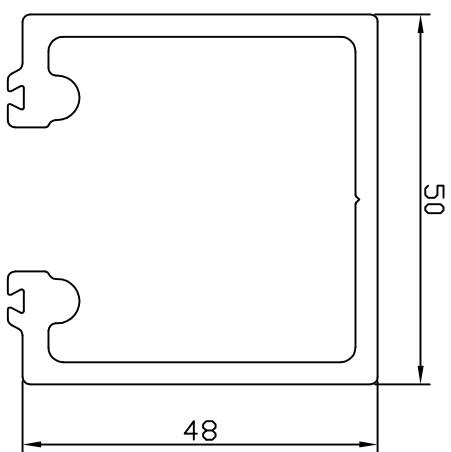
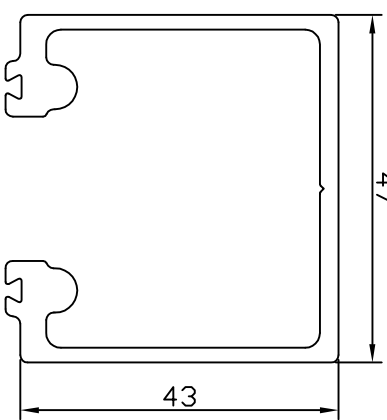
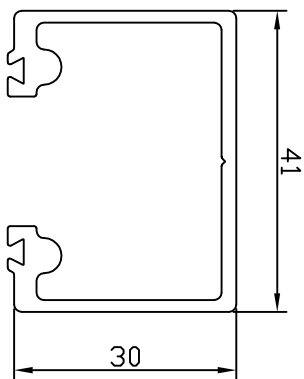
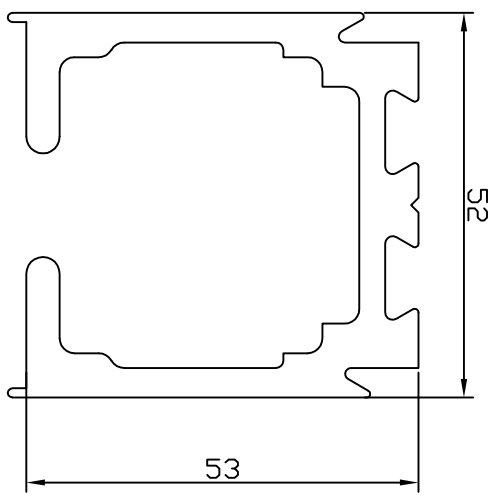

120 Top Track
Aluminium

180 Top Track
Aluminium

250 Top Track
Aluminium

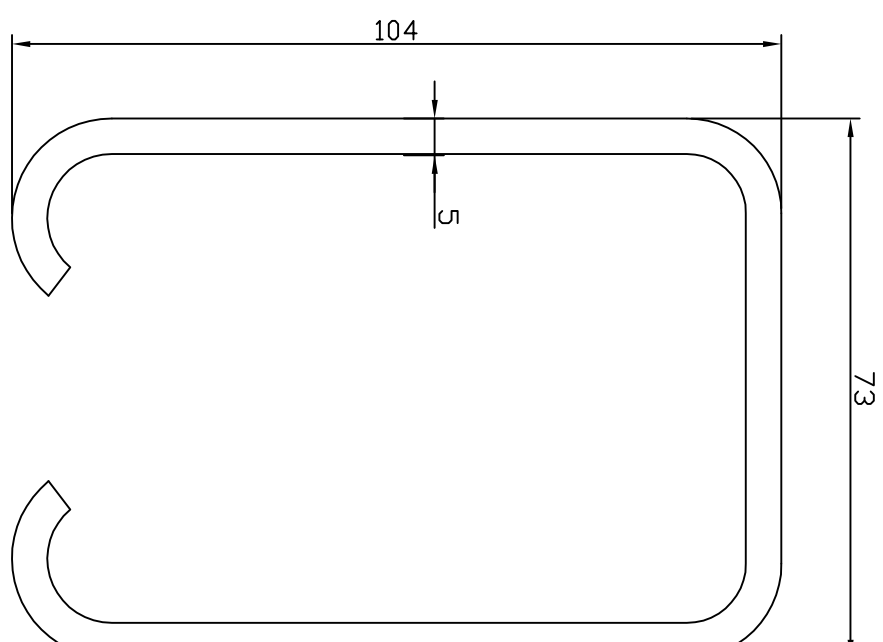
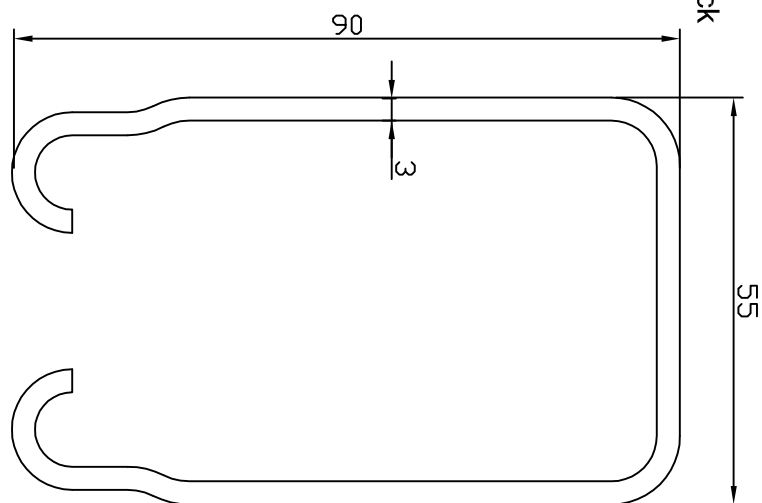
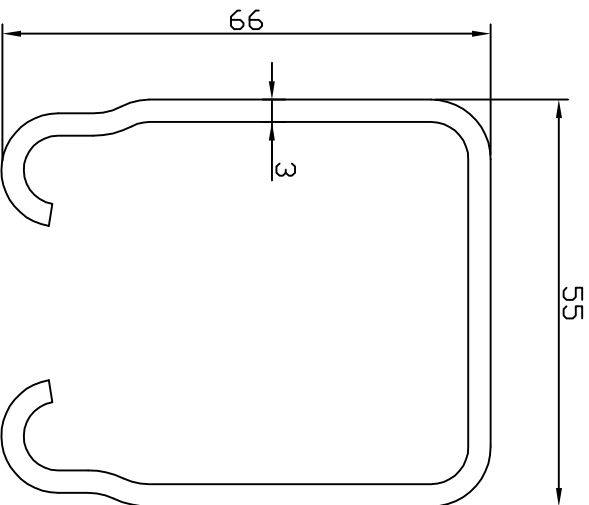
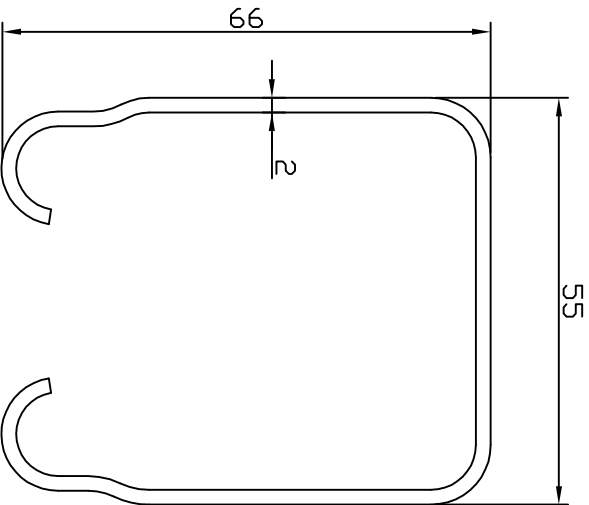
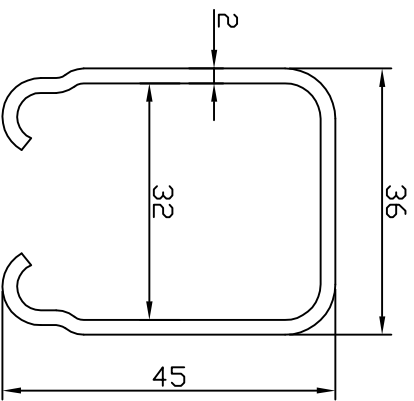

290 Top Track
Steel

301 Top Track
Steel

301H Top Track
Steel

305 Top Track
Steel

307 Top Track
Zinc Plated Steel

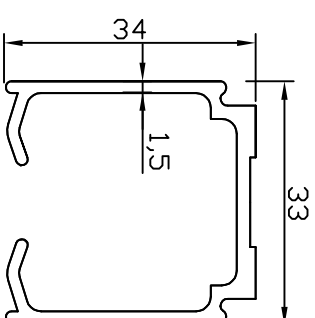
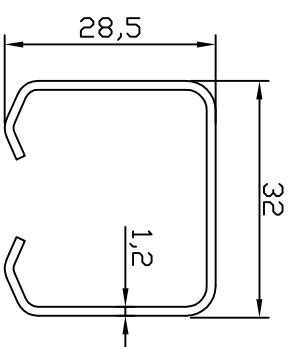
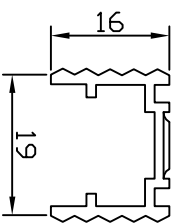
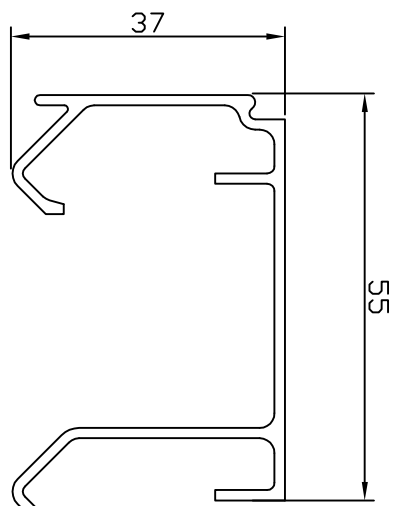
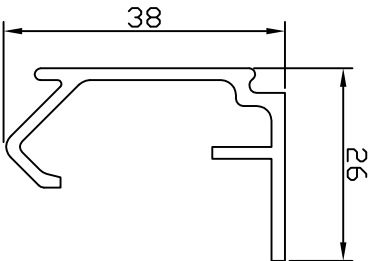
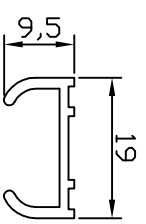

130 Top Track
Aluminium

21A Top Track
Aluminium

20A Top Track
Aluminium

310 Top Track
Aluminium

280 Top Track
Steel

280A Top Track
Aluminium

