

Sliding room dividing doors up to 55kg & 90kg per leaf

Marathon 55 & 90

Domestic Straight Sliding Door Gear – up to 90kg per leaf

Application

► For heavily used timber or metal doors, offering smooth and reliable action due to its precision engineering, solid alloy runner bar and one piece ball cage design.

Door Specification

Max height 3000mm
 Max leaf weight 55 or 90kg
 For internal fitting, can be face or soffit fixed (With additional brackets).

Kit Sets

For door opening widths to	Junior kit 55kg	Senior kit 90kg
400-750mm	J2	
750-900mm	J3	S3
900-1050mm	J4	S4
1050-1200mm	J5	S5
1200-1500mm	J6	S6

Single door kits for max. door weights of 55kg and 90kg contain: top assembly (track, hanger plates, ball cage and runner bar); 2 nylon top plates (with integral buffer); wall mounted stops; nylon floor guide (guide channel to be mortised into door bottom rail).

Optional Extras:

Soffit fixing brackets - Space at max 600mm centres	3/40/1
Self-closing system pulley assembly	SCK1 (advise door weight)
Pelmet	40P/1854P
Pelmet end caps	EC40PW
Flushpull	400

***Important:** Track cannot be cut down to size on-site so accurate ordering is essential.

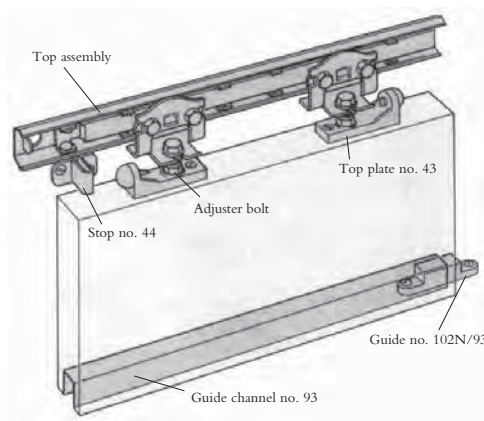

FACE FIXED SOFFIT FIXED

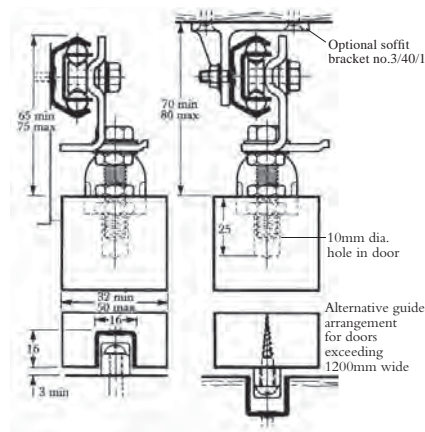

Fitting Instructions:

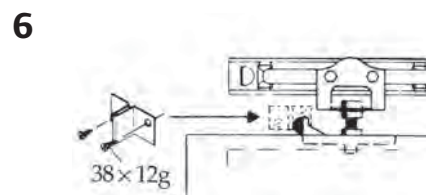
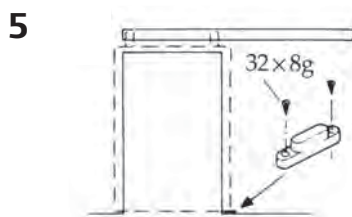
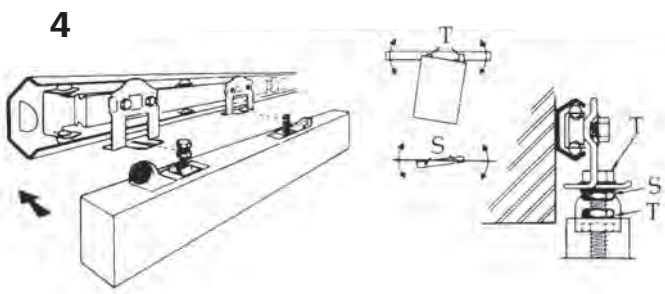
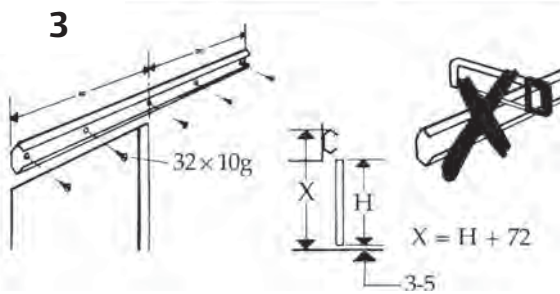
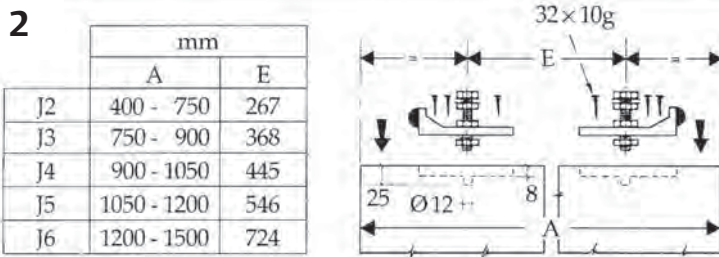
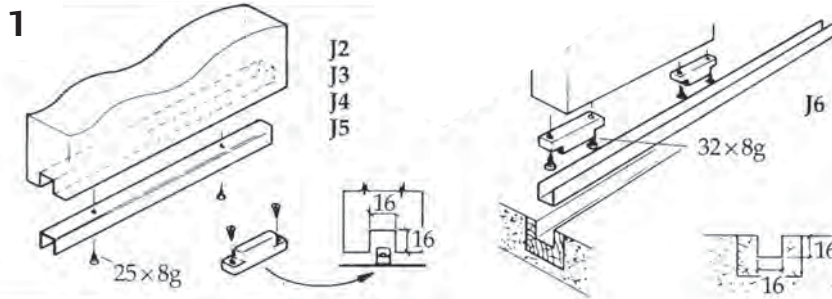
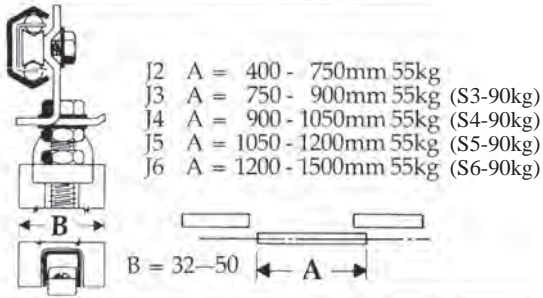

All dimensions in mm