

Husky 100

Sliding room dividing doors
up to 100kg per leaf

Application

- ▶ Reliable and highly versatile gear using precision-made components for trouble free operation.

Door Specification

Max leaf height 2400mm

Max leaf weight 100kg

Timber or metal framed doors.

For non-standard installations:

Track:	280	Galvanised steel
	280A	Aluminium (mill)
	280AN	Aluminium (Anodised)

Door fittings pack H100N

Includes two hangers, track stop, retaining stop, floor guide and adjustment spanner.

Track is available in lengths of 2000mm, 3000mm, 4000mm, and 6000mm.

Brackets:

For mounting track to the face of a wall, space at max 600mm centres.

Aluminium track brackets 281A

Aluminium track jointing brackets 281AX

Kit Sets

Kit set for individual doors include a length of track, wall mounting brackets and a door fittings pack.

Max leaf size	Max leaf weight	Steel Track	Aluminium Track
2400 x 800 x 50mm	100kg	H100/15	H100/15A
2400 x 950 x 50mm	100kg	H100/18	H100/18A
2400 x 1050 x 50mm	100kg	H100/20	H100/20A
2400 x 1250 x 50mm	100kg	H100/24	H100/24A

Optional Extras:

Hanger for metal doors 285

Nylon tipped guide 106N/94

Aluminium floor channel 94x

Available in 2000mm, 3000mm, 4000mm, and 6000mm.

Flushpull 414

Flushpull 400

Track is also available in an anodised aluminium finish.

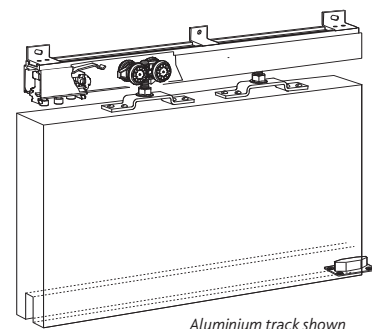

Fitting Instructions: Aluminium track

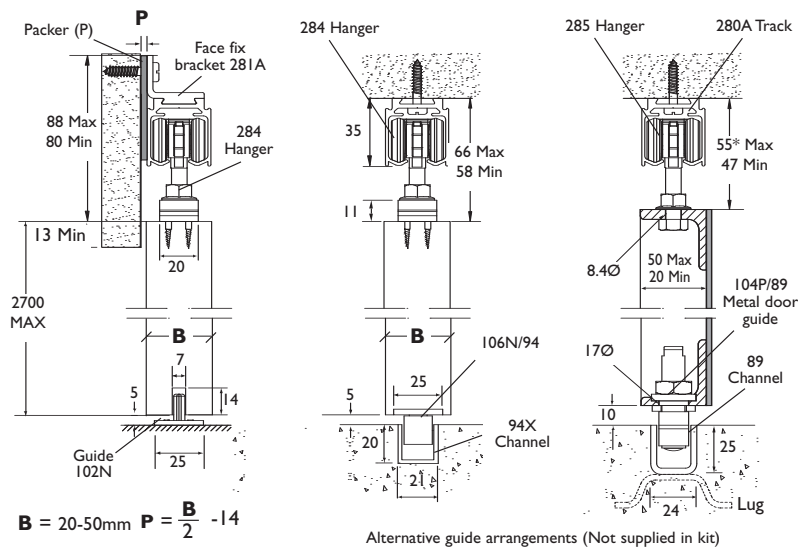

1 ASSEMBLY OF RETAINING STOP, HANGER & TRACK STOP

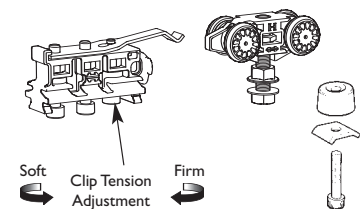

2 REBATE DOOR for 102N (if required)

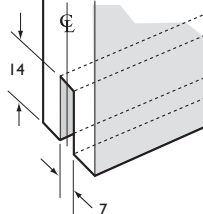

3 ALTERNATIVE GUIDE

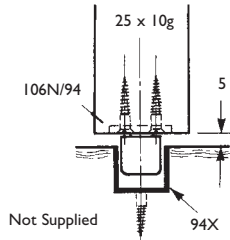

4 FIT HANGER APRON TO DOOR PANEL

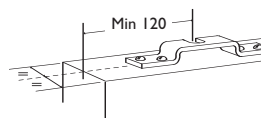

5 INSERT HANGERS AND RETAINING STOP

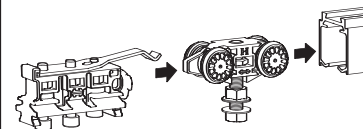

6 SECURE TRACK

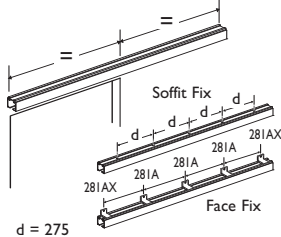

7 FACE & SOFFIT FIX OPTIONS

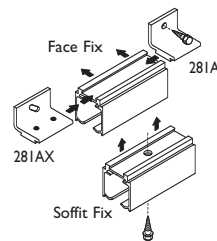

8 BRACKET AND CLIPSTOP LOCATIONS

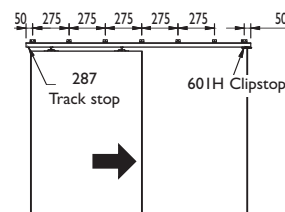

9 FIT HANGER APRON TO DOOR PANEL AND ADJUST HEIGHT

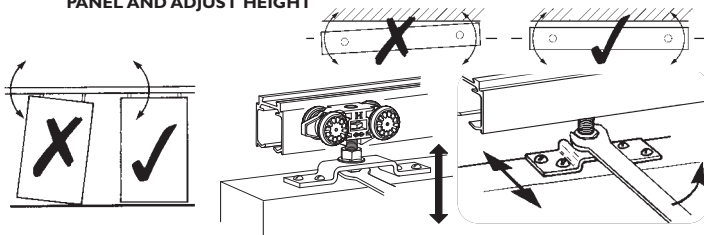

10 FIT DOOR GUIDE

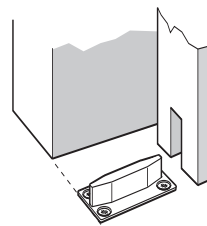

11 POSITION AND SECURE RETAINING STOP

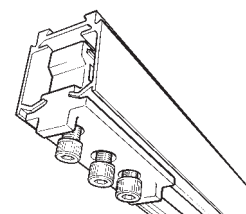

All dimensions in mm

Fitting Instructions: Steel Track

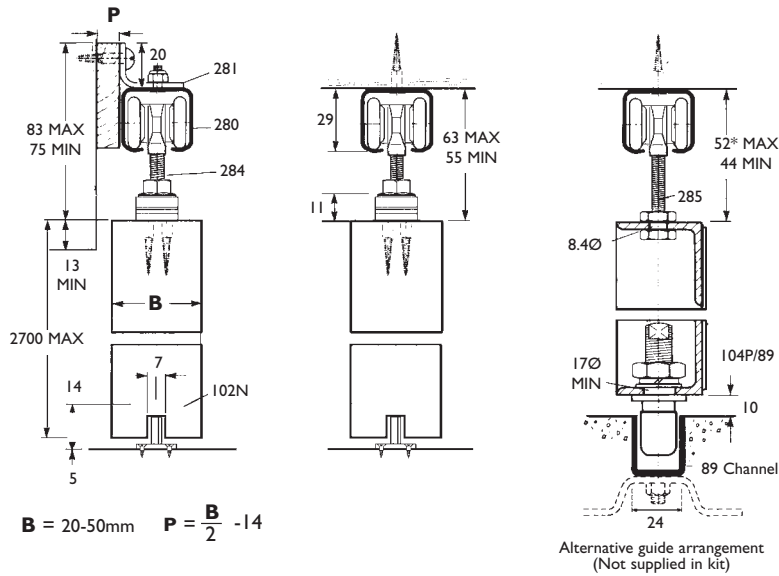

1 ASSEMBLY OF RETAINING STOP, HANGER & TRACK STOP

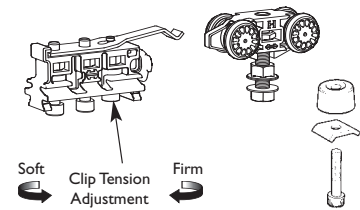

2 REBATE DOOR for 102N (if required)

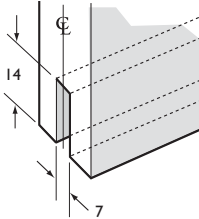

3 ALTERNATIVE GUIDE

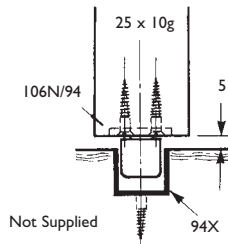

4 FIT HANGER APRON TO DOOR PANEL

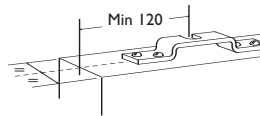

5 INSERT HANGERS AND RETAINING STOP

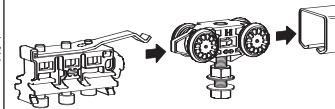

5 SECURE TRACK

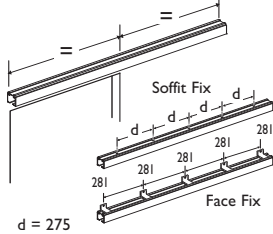

7 FACE & SOFFIT FIX OPTIONS

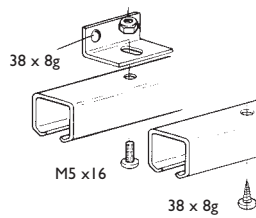

8 BRACKET AND CLIPSTOP LOCATIONS

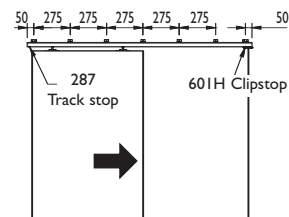

9 FIT HANGER APRON TO DOOR PANEL AND ADJUST HEIGHT

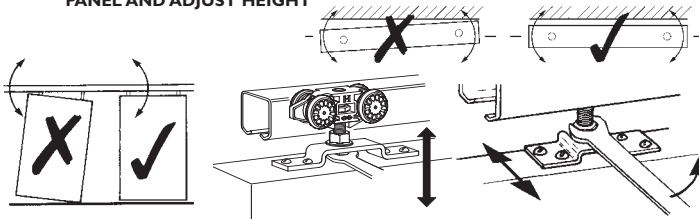

10 FIT DOOR GUIDE

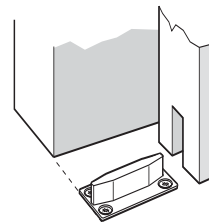

11 POSITION AND SECURE RETAINING STOP

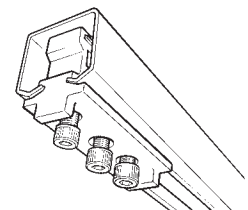

All dimensions in mm

Domestic Straight Sliding Door Gear - up to 100kg per leaf